

Fig. FS1 : General schematic diagram of fibre communication link and atmospheric communication link.

$U(\mathbf{R}, t)$  is given, where  $\mathbf{R} = (r, \phi, z)$  or  $\mathbf{R} = (x, y, z)$  and  $t$  is time dependence, then  $U(\mathbf{R}, t)$  satisfies the following

$$\nabla^2 U(\mathbf{R}, t) - c^{-2} \frac{\partial^2 U(\mathbf{R}, t)}{\partial t^2} = 0 \quad \dots \text{Wave equation} \quad (\text{B1})$$

After we assume a sinusoidal time dependence, i.e.  $U(\mathbf{R}, t) = U(\mathbf{R}) \exp(j\omega t)$ , then we obtain

$$(\nabla^2 + k^2)U(\mathbf{R}) = 0 \quad \dots \text{Helmholtz equation} \quad (\text{B2})$$

The Laplacian operator,  $\nabla^2$  is respectively expressed in cylindrical and Cartesian coordinates as follows

$$\nabla^2 = \frac{1}{r} \frac{\partial}{\partial r} \left( r \frac{\partial}{\partial r} \right) + \frac{1}{r^2} \frac{\partial^2}{\partial \phi^2} + \frac{\partial^2}{\partial z^2} = \frac{1}{r} \frac{\partial}{\partial r} + \frac{\partial^2}{\partial r^2} + \frac{1}{r^2} \frac{\partial^2}{\partial \phi^2} + \frac{\partial^2}{\partial z^2} \quad \text{in cylindrical coordinates} \quad (\text{B3a})$$

$$\nabla^2 = \frac{\partial^2}{\partial x^2} + \frac{\partial^2}{\partial y^2} + \frac{\partial^2}{\partial z^2} \quad \text{in Cartesian coordinates} \quad (\text{B3b})$$

Thus, Helmholtz equation for cylindrical coordinates is

$$\frac{1}{r} \frac{\partial U(\mathbf{R})}{\partial r} + \frac{\partial^2 U(\mathbf{R})}{\partial r^2} + \frac{1}{r^2} \frac{\partial^2 U(\mathbf{R})}{\partial \phi^2} + \frac{\partial^2 U(\mathbf{R})}{\partial z^2} + k^2 U(\mathbf{R}) = 0 \quad \text{in cylindrical coordinates} \quad (\text{B4})$$

Now we assume a  $z$  dependence of  $\exp(jkz)$ , such that  $U(\mathbf{R}) = U(\mathbf{r}) \exp(jkz)$ , where  $\mathbf{r} = (r, \phi)$  or  $\mathbf{r} = (x, y)$  Then Helmholtz equation will

become

$$\frac{1}{r} \frac{\partial}{\partial r} \left[ r \frac{\partial U(\mathbf{r})}{\partial r} \right] + \frac{1}{r^2} \frac{\partial^2 U(\mathbf{r})}{\partial \phi^2} + \frac{\partial^2 U(\mathbf{r})}{\partial z^2} + 2jk \frac{\partial U(\mathbf{r})}{\partial z} = 0 \quad \text{in cylindrical coordinates} \quad (\text{B5})$$

Usually, the optical propagation is confined to  $z$  axis. This means that the transverse distance is much smaller the axial distance, then we may

drop the term  $\frac{\partial^2 U(\mathbf{r})}{\partial z^2}$  since it is too small with respect to the others. The remaining part of the wave equation is called the paraxial wave

equation (PWE). This is shown below

$$\frac{1}{r} \frac{\partial}{\partial r} \left[ r \frac{\partial U(\mathbf{r})}{\partial r} \right] + \frac{1}{r^2} \frac{\partial^2 U(\mathbf{r})}{\partial \phi^2} + 2jk \frac{\partial U(\mathbf{r})}{\partial z} = \frac{1}{r} \frac{\partial U(\mathbf{r})}{\partial r} + \frac{\partial^2 U(\mathbf{r})}{\partial r^2} + \frac{1}{r^2} \frac{\partial^2 U(\mathbf{r})}{\partial \phi^2} + 2jk \frac{\partial U(\mathbf{r})}{\partial z} = 0 \quad \text{PWE in cylindrical coordinates} \quad (\text{B6})$$

Simple waves (optical fields)

#### A) Plane wave

The expression for a plane wave at source (transmitter) at  $z = 0$  is

$$U(\mathbf{R}) = U(\mathbf{r}, z = 0) = A_0 \exp(j\phi_0) \quad (\text{B7})$$

Note that the expression of plane wave on the right hand side contains no coordinate dependence. As shown in (4.2.2) of notes, entitled

“Attenuation and dispersion in fibres\_March 2013\_HTE”, after propagating an axial distance of  $z > 0$ , this plane wave becomes

$$U(\mathbf{R}) = U(\mathbf{r}, z) = A_0 \exp(j\phi_0 + jkz) \quad (\text{B8})$$

which means that plane wave remains as plane wave upon propagation with changes occurring only in the phase. Note that plane wave satisfies Helmholtz equation as shown in the MATLAB code PWETest\_ECE474.m.

**Exercise B1:** Prove that the plane wave given in (B8) satisfies Helmholtz equation given in (B5) by hand derivation.

B) Spherical wave

The expression for a plane wave at source (transmitter) at  $z = 0$  is

$$U(\mathbf{R}) = U(\mathbf{r}, z = 0) = \lim_{R \rightarrow 0} \frac{\exp(jkR)}{4\pi R} \quad (\text{B9})$$

This way, spherical wave describes a point source. At a distance  $z > 0$  from the transmitter, spherical wave can be approximated by

$$U(\mathbf{R}) = U(\mathbf{r}, z) \simeq \frac{1}{4\pi z} \exp\left(jkz + \frac{jkz^2}{2z}\right) \quad (\text{B10})$$

Note that since above representation is an approximation, it does not satisfy Helmholtz equation as also shown by the m code

PWETest\_ECE474.m.

It is not possible to characterize all cases by plane or spherical waves. For this reason we introduce the fundamental Gaussian beam wave below.

For the source coordinate representation, we choose  $\mathbf{s}$ , so  $\mathbf{r}$  is the coordinate for receiver plane,  $\mathbf{s} = (s, \phi_s)$  for cylindrical coordinates ,

$\mathbf{s} = (s_x, s_y)$  for Cartesian coordinates . Hence below,  $U_s(\ )$  represent the field on the source plane.

Fundamental Gaussian Beam Wave on source plane

$$U_s(s, \phi_s) = A_c \exp(-k\alpha s^2) \quad \text{in cylindrical coordinates} \quad (\text{G1a})$$

$$U_s(s_x, s_y) = A_c \exp\left[-0.5k(\alpha_x s_x^2 + \alpha_y s_y^2)\right] \quad \text{in Cartesian coordinates} \quad (\text{G1b})$$

where  $A_c$  is the amplitude coefficient,  $k = 2\pi/\lambda$  is the wave number with  $\lambda$  being the wavelength,  $\alpha = 1/(k\alpha_s^2) + 0.5j/F_s$  where  $\alpha_s$  and  $F_s$  respectively refer to radial Gaussian source size and focusing parameter,  $j = \sqrt{-1}$ . Similar definitions apply to Cartesian case. Note that in cylindrical coordinates, there is no  $\phi_s$  dependence, thus perfect angular symmetry.

To see the profile of this beam, we usually plot the intensity, which is given by

$$I_s(s, \phi_s) = U_s(s, \phi_s)U_s^*(s, \phi_s) \quad * \text{ indicating conjugate} \quad (\text{G2a})$$

$$I_s(s_x, s_y) = U_s(s_x, s_y)U_s^*(s_x, s_y) \quad (\text{G2b})$$

$$I_{sN} = I_s(\ ) / \max[I_s(\ )] \quad (\text{G2c})$$

By substituting from (G1a) and (G1b) into (G2a) and (G2b), intensity will become

$$I_s(s, \phi_s) = A_c^2 \exp\left[-k\left(\frac{1}{k\alpha_s^2} + \frac{0.5j}{F_s} + \frac{1}{k\alpha_s^2} - \frac{0.5j}{F_s}\right)s^2\right] = A_c^2 \exp\left(-\frac{2s^2}{\alpha_s^2}\right), \quad I_s(s_x, s_y) = A_c^2 \exp\left(-\frac{s_x^2}{\alpha_{sx}^2} - \frac{s_y^2}{\alpha_{sy}^2}\right) \quad (\text{G3a})$$

From the m file GaussianbeamS.m, it is possible to see the 3D plots, contour plots and 2D plots of Gaussian beam intensity profiles at different source sizes, namely  $\alpha_s = 0.1$  cm, 1 cm, 2 cm, 5 cm. These are shown in Figs. GB-1, GB-2 and GB-3. As the measurements taken, by pointing data cursor to the appropriate locations, we measure approximately the given source sizes at the point of  $s = \alpha_s$ . Note that at the points of  $s = \alpha_s$ ,  $s_x = \alpha_{sx}$ ,  $s_y = \alpha_{sy}$ , the intensity expressions in (G3a) will assume the following numeric values

$$I_s(s, \phi_s) = A_c^2 \exp\left[-\frac{2(s = \alpha_s)^2}{\alpha_s^2}\right] = A_c^2 \exp(-2) = 0.1353, \quad I_s(s_x, s_y) = A_c^2 \exp\left[-\frac{(s_x = \alpha_{sx})^2}{\alpha_{sx}^2} - \frac{(s_y = \alpha_{sy})^2}{\alpha_{sy}^2}\right] = A_c^2 \exp(-2) = 0.1353 \quad \text{if } A_c = 1 \quad (\text{G3b})$$

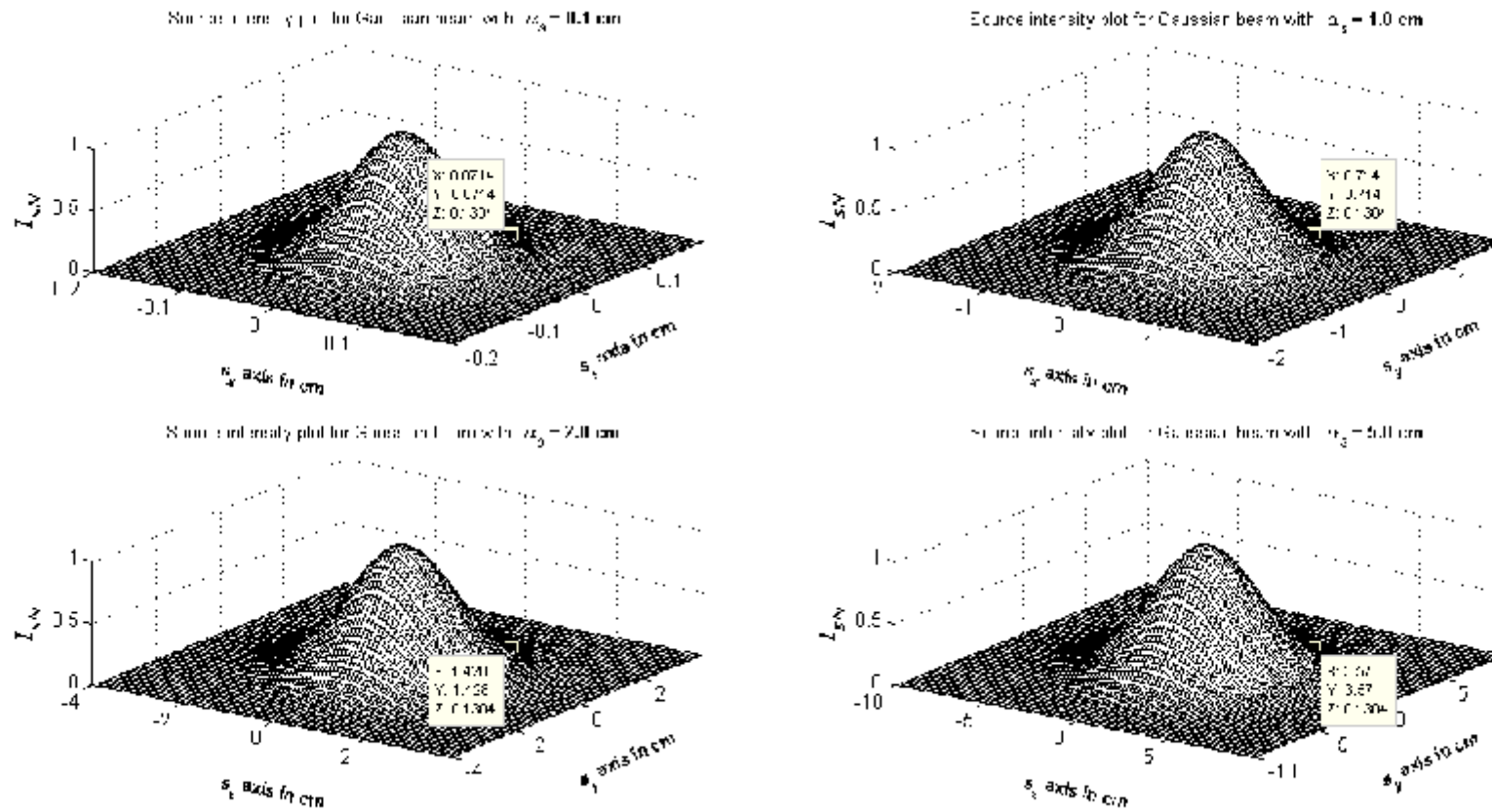
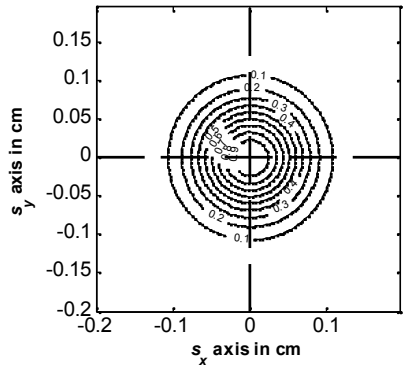
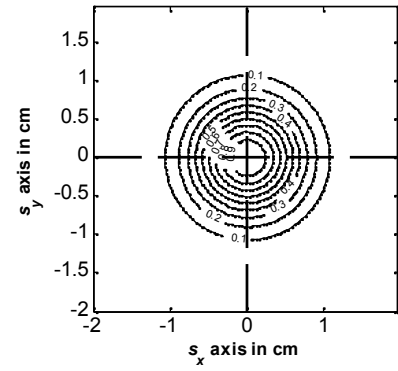

Fig. GB-1 3D plots of Gaussian beams at  $\alpha_s = 0.1$  cm, 1 cm, 2 cm, 5 cm with data cursors pointed to approximately  $\exp(-2) = 0.1353$ .

Source intensity plot for Gaussian beam with  $\alpha_s = 0.1$  cm



Source intensity plot for Gaussian beam with  $\alpha_s = 1.0$  cm



Source intensity plot for Gaussian beam with  $\alpha_s = 2.0$  cm

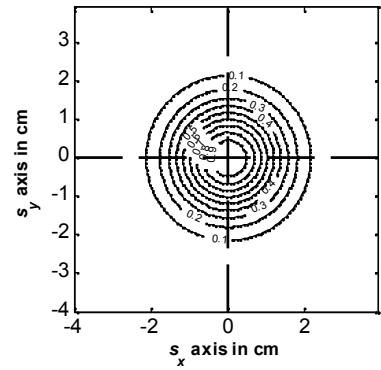

Source intensity plot for Gaussian beam with  $\alpha_s = 5.0$  cm

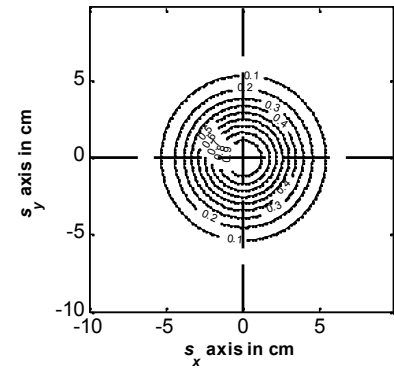

Fig. GB-2 Contour plots of Gaussian beams at  $\alpha_s = 0.1$  cm, 1 cm, 2 cm, 5 cm .

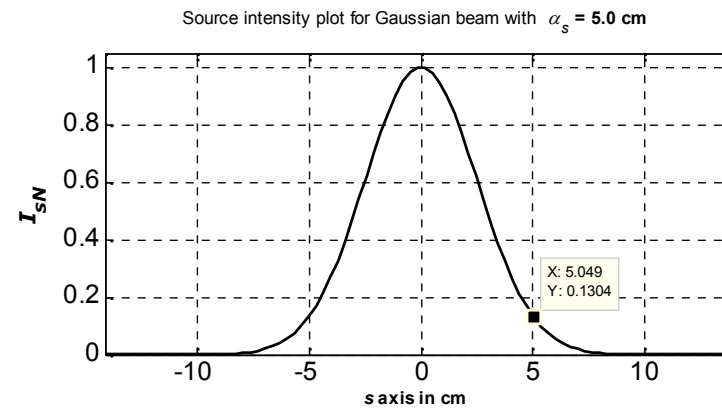
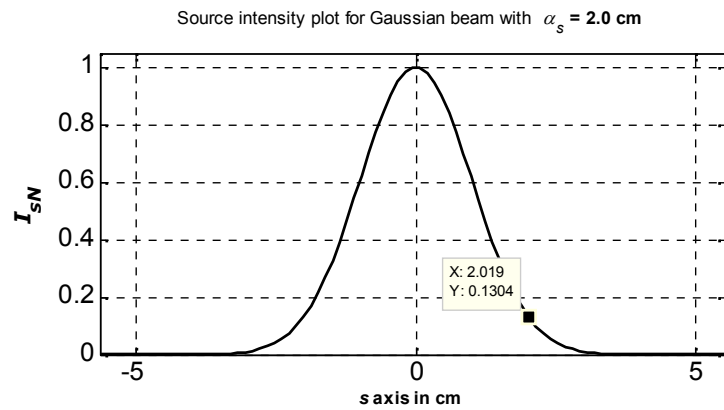
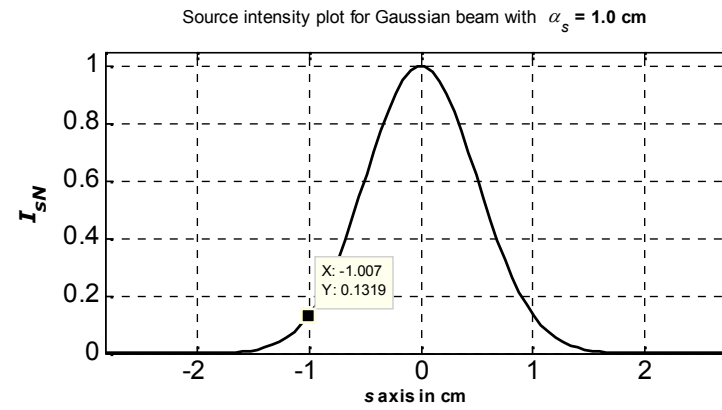
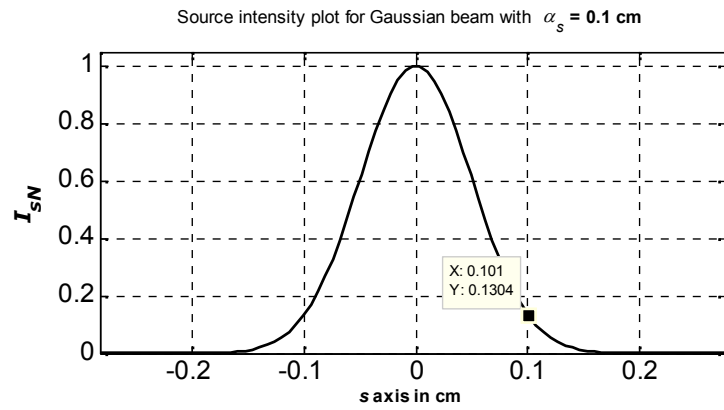

Fig. GB-3 2D plots of Gaussian beams (cut along the diagonal axis) at  $\alpha_s = 0.1$  cm, 1 cm, 2 cm, 5 cm with data cursors pointed to approximately  $\exp(-2) = 0.1353$ .



## Fundamental Gaussian Beam Wave on receiver plane

Now we try to find the receiver field for a Gaussian source beam.

This can be done in two ways

### A) Direct Solution Method

We postulate the field on the receiver plane at a  $z$  distance away from the source to be in the form of

$$U_r(r, \phi_r) = A(z) \exp\left[-\frac{k\alpha r^2}{p(z)}\right] \quad \text{in cylindrical coordinates} \quad (G4)$$

Where  $A(z)$  and  $p(z)$  are the parameters to be determined subject to initial conditions of the source plane. This way by comparing (G4) with (G1a), we deduce that

$$A(z=0) = A_c, \quad p(z=0) = 1 \quad (G5)$$

On the other hand, (G4) should satisfy the PWE in (B6), thus by substituting (G4) in (B6) and rearranging we get the following differential equation

$$2k^2\alpha^2 r^2 A(z) + jk^2\alpha r^2 A(z)p'(z) - 2k\alpha A(z)p(z) + jkA'(z)p^2(z) = 0 \quad (G6)$$

By setting the coefficients of  $r^2$  and  $r^0$  (which are the first two and the last two terms in (G6)) independently to zero will yield

$$r^2 : p'(z) = 2j\alpha = \frac{j}{k\alpha_s^2} - \frac{0.5}{F_s} \quad (\text{G7a})$$

$$r^0 : A'(z) = -\frac{2j\alpha}{p(z)} A(z) = -\frac{p'(z)}{p(z)} A(z) \quad (\text{G7b})$$

From (G7), we get the solutions as

$$p(z) = 1 + 2j\alpha z, \quad A(z) = \frac{1}{p(z)} = \frac{1}{1 + 2j\alpha z} \quad (\text{G8})$$

Returning to (G4), with this arrangement, the receiver field expression will be

$$U_r(r, \phi_r) = \frac{A_c}{1 + 2j\alpha z} \exp\left(-\frac{k\alpha r^2}{1 + 2j\alpha z}\right) \quad (\text{G9})$$

Note that similar to the source field, since there is angular symmetry, the angular variable  $\phi_r$  is dummy. With the inclusion of  $\exp(jkz)$ , the receiver field will be

$$U_r(r, \phi_r, z) = \frac{A_c \exp(jkz)}{1 + 2j\alpha z} \exp\left(-\frac{k\alpha r^2}{1 + 2j\alpha z}\right) \quad (\text{G10})$$

From the test in the m file PWETest\_ECE474.m, it is seen that (G9) satisfies the PWE, not the Helmholtz equation. Now we turn to the second method called Huygens-Fresnel integral

B) Huygens-Fresnel integral

Huygens-Fresnel integral is used to find the receiver field from a given source field of  $U_s(s, \phi_s)$  via double integration as shown below

$$U_r(r, \phi_r, z) = \frac{-jk \exp(jkz)}{2\pi z} \int_0^\infty \int_0^{2\pi} ds d\phi_s s U_s(s, \phi_s) \exp\left\{\frac{jk}{2z}[-2rs \cos(\phi_r - \phi_s) + s^2 + r^2]\right\} \quad \text{in cylindrical coordinates} \quad (\text{G11})$$

where the exponential inside the integrand is known as the diffraction term, i.e. it describes how the optical wave diffracts (opens up, spreads, hence the wavefront becomes wider) as it propagates in free space. This diffraction exponential is derived from the Green's function using the paraxial approximation. Note that there is a Cartesian coordinate equivalence of (G11) as given below

$$U_r(r_x, r_y, z) = \frac{-jk \exp(jkz)}{2\pi z} \int_{-\infty}^\infty \int_{-\infty}^\infty ds_x ds_y U_s(s_x, s_y) \exp\left\{\frac{jk}{2z}[-2s_x r_x - 2s_y r_y + s_x^2 + s_y^2 + r_x^2 + r_y^2]\right\} \quad \text{in Cartesian coordinates} \quad (\text{G12})$$

The simplified diagram of source and receiver in Cartesian coordinates is shown in the following picture. Here we shall continue with (G11).

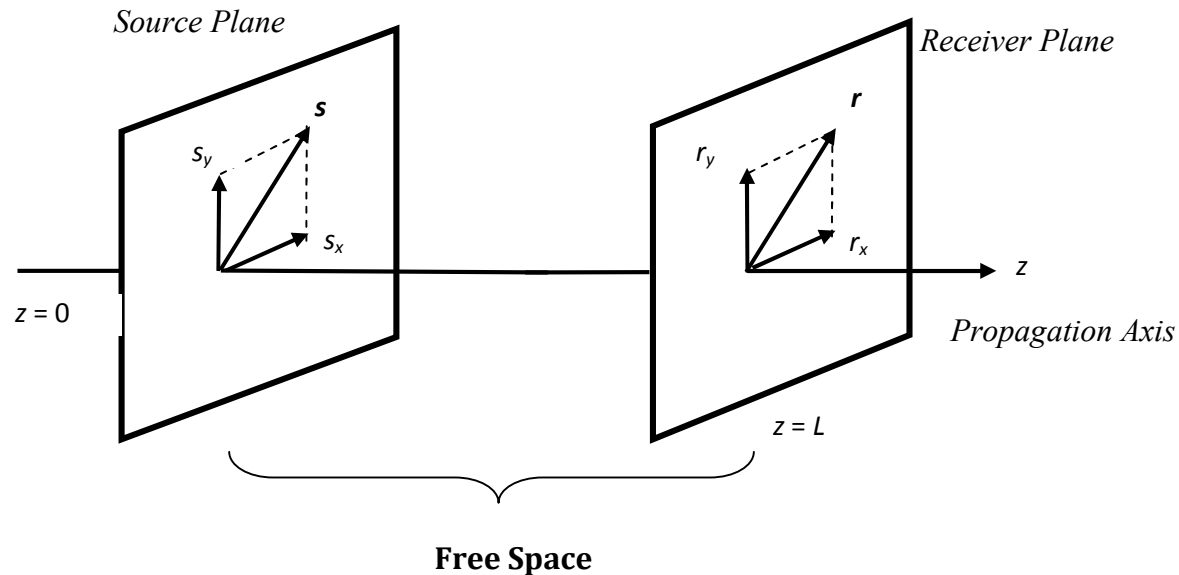

By inserting from (G1a) for  $U_s(s, \phi_s)$  in (G11) we get

$$\begin{aligned}
 U_r(r, \phi_r, z) &= \frac{-jk \exp(jkz)}{2\pi z} A_c \exp\left(\frac{jkr^2}{2z}\right) \int_0^\infty \int_0^{2\pi} ds d\phi_s s \exp(-k\alpha s^2) \exp\left\{\frac{jk}{2z}[-2rs \cos(\phi_r - \phi_s) + s^2]\right\} \\
 &= \frac{-jk \exp(jkz)}{2\pi z} A_c \exp\left(\frac{jkr^2}{2z}\right) \int_0^\infty ds s \exp\left(-k\alpha s^2 + \frac{jks^2}{2z}\right) \int_0^{2\pi} d\phi_s \exp\left\{\frac{jk}{2z}[-2rs \cos(\phi_r - \phi_s)]\right\} \quad (G13)
 \end{aligned}$$

The outer integral, i.e. the integral with respect to  $\phi_s$  can be solved using the following

$$\int_0^{2\pi} d\phi_s \exp\left[-\frac{jk}{z} rs \cos(\phi_r - \phi_s)\right] = 2\pi J_0\left(\frac{krs}{z}\right) \quad (G14) \quad \text{This is a reduced version of 3.937.2 of Gradshteyn and Ryzhik 2007, pp. 496}$$

Then the remaining part of the integral over  $s$  is in the following form and can be solved via

$$\int_0^\infty ds s J_0\left(\frac{krs}{z}\right) \exp\left[\left(-k\alpha + \frac{jk}{2z}\right) s^2\right] = \frac{z}{2k\alpha z - jk} \exp\left[-\frac{kr^2}{z(4\alpha z - 2j)}\right] \quad (G15) \quad \text{This is a reduced version of 6.631.4 of Gradshteyn and Ryzhik 2007, pp. 706}$$

Collecting all terms and simplifying, the received field of Gaussian beam will be

$$U_r(r, \phi_r, z) = A_c \frac{\exp(jkz)}{1 + 2j\alpha z} \exp\left(-\frac{k\alpha r^2}{1 + 2j\alpha z}\right) \quad (G16)$$

As seen, (G16) which is obtained by the Huygens-Fresnel integral method is the same as (G10) which is the result from Direct Solution method.

Now we turn to illustration of receiver plane intensity profile of Gaussian beam. Benefiting from (G2a) and using (G16), receiver intensity can be written as

$$I_r(r, \phi_r, z) = U_r(r, \phi_r, z)U_r^*(r, \phi_r, z) = \frac{A_c^2}{1 + 2j(\alpha - \alpha^*)z + 4|\alpha|^2 z^2} \exp\left[-kr^2 \frac{\alpha + \alpha^*}{1 + 2j(\alpha - \alpha^*)z + 4|\alpha|^2 z^2}\right] \quad (G17)$$

(G17) is plotted in GaussianbeamR.m file. Although running this m file will show how intensity evolves along the propagation axis, it is more instructive to plot the variation of beam size, since the general profile of the Gaussian beam remains Gaussian upon propagation, where the beam spreads more and more with increasing propagation distance due to diffraction.

Converting (G17) into an expression in terms of source size and the focusing parameter, we get

$$I_r(r, \phi_r, z) = \frac{A_c^2 k^2 \alpha_s^4 F_s^2}{k^2 \alpha_s^4 F_s^2 - 2k^2 \alpha_s^4 F_s z + 4F_s^2 z^2 + k^2 \alpha_s^4 z^2} \exp\left(-r^2 \frac{2k^2 \alpha_s^2 F_s^2}{k^2 \alpha_s^4 F_s^2 - 2k^2 \alpha_s^4 F_s z + 4F_s^2 z^2 + k^2 \alpha_s^4 z^2}\right) \quad (G18)$$

Assuming no loss of power during propagation, the total power on source or on receiver plane will be

$$P = \int_0^{\infty} \int_0^{2\pi} d\phi_s s ds U_s(s, \phi_s) U_s^*(s, \phi_s) = \int_0^{\infty} \int_0^{2\pi} d\phi_s s ds I_s(s, \phi_r) = 2\pi \int_0^{\infty} s ds I_s(s) = \int_0^{\infty} \int_0^{2\pi} d\phi_r r dr I_r(r, \phi_r, z) = 2\pi \int_0^{\infty} r dr I_r(r, z) \quad (G19)$$

Now by using either (G3) or (G18) and the following integration formula

$$P = \int_0^{\infty} dx x \exp(-\beta x^2) = \frac{1}{2\beta} \quad \text{This is a modified version of 3.321.4 or 3.326.2 of Gradshteyn and Ryzhik 2007 on pp. 336 and pp. 337 respectively} \quad (G20)$$

$P$  will become

$$P = A_c^2 \frac{\pi}{2} \alpha_s^2 \quad (\text{G21})$$

As expected, the power is directly proportional to the source size,  $\alpha_s$  on the source plane.

In order to examine the changes of beam size (named as such on receiver plane), we formulate the beam size as follows

$$\alpha_r = \left[ 2 \int_0^\infty \int_0^{2\pi} d\phi_r r^3 dr I_r(r, \phi_r, z) / P \right]^{1/2} = \left[ 4\pi \int_0^\infty r^3 dr I_r(r, z) / P \right]^{1/2} \quad (\text{G22})$$

Performing the integration in (G22) using

$$\int_0^\infty dx x^m \exp(-\beta x^n) = \frac{\Gamma\left(\frac{m+1}{n}\right)}{n\beta^{m/n}} \quad \text{This is 3.326.2 of Gradshteyn and Ryzhik 2007 on pp. 337} \quad (\text{G23})$$

where  $\Gamma(\ )$  is the Gamma function,  $\alpha_r$  turns into

$$\alpha_r = \left( \frac{k^2 \alpha_s^4 F_s^2 - 2k^2 \alpha_s^4 F_s z + 4F_s^2 z^2 + k^2 \alpha_s^4 z^2}{k^2 \alpha_s^2 F_s^2} \right)^{1/2} \quad (\text{G24})$$

Considering the format in (G18) and (G24), the receiver intensity expression can be written as

$$I_r(r, \phi_r, z) = \frac{A_c^2 \alpha_s^2}{\alpha_r^2} \exp\left(-\frac{2r^2}{\alpha_r^2}\right) \quad (\text{G25})$$

To find the variation of the focusing parameter, usually called the radius of curvature, along the propagation axis, we first take (G1a) and write it as

$$U_s(s, \phi_s) = A_c \exp(-k\alpha s^2) = A_c \exp\left(-\frac{s^2}{\alpha_s^2} - \frac{jks^2}{2F_s}\right) \quad (\text{G26})$$

Then from (G16) we try to write the receiver field in the same format as that of RHS

$$\begin{aligned} U_r(r, \phi_r, z) &= A_c \frac{\exp(jkz)}{1+2j\alpha z} \exp\left(-\frac{k\alpha r^2}{1+2j\alpha z}\right) = A_c \frac{\exp(jkz)}{1+2j\alpha z} \exp\left[-r^2 \frac{k\alpha(1-2j\alpha^*z)}{(1+2j\alpha z)(1-2j\alpha^*z)}\right] \\ &= A_c \frac{\exp(jkz)}{1+2j\alpha z} \exp\left(-r^2 \frac{k^2\alpha_s^2 F_s^2}{k^2\alpha_s^4 F_s^2 - 2k^2\alpha_s^4 F_s z + 4F_s^2 z^2 + k^2\alpha_s^4 z^2} + \frac{jkr^2}{2} \frac{4F_s^2 z - k^2\alpha_s^4 F_s + k^2\alpha_s^4 z}{k^2\alpha_s^4 F_s^2 - 2k^2\alpha_s^4 F_s z + 4F_s^2 z^2 + k^2\alpha_s^4 z^2}\right) \\ &= A_c \frac{\exp(jkz)}{1+2j\alpha z} \exp\left(-\frac{r^2}{\alpha_r^2} - j\frac{kr^2}{2F_r}\right) \end{aligned} \quad (\text{G27})$$

Hence the radius of curvature at receiver plane becomes

$$F_r = -\frac{k^2\alpha_s^4 F_s^2 - 2k^2\alpha_s^4 F_s z + 4F_s^2 z^2 + k^2\alpha_s^4 z^2}{4F_s^2 z - k^2\alpha_s^4 F_s + k^2\alpha_s^4 z} \quad (\text{G28})$$

The variations of beam size and radius of curvature are investigated in the m files, Beamsize.m and Focusingpram.m. These files will also be used in the experiments. Depending on the initial value of  $F_s$ , the beams are classified as

- a)  $F_s \rightarrow \infty$ . This is called collimated beam, it diffracts slowly as we go away from the source plane as shown below

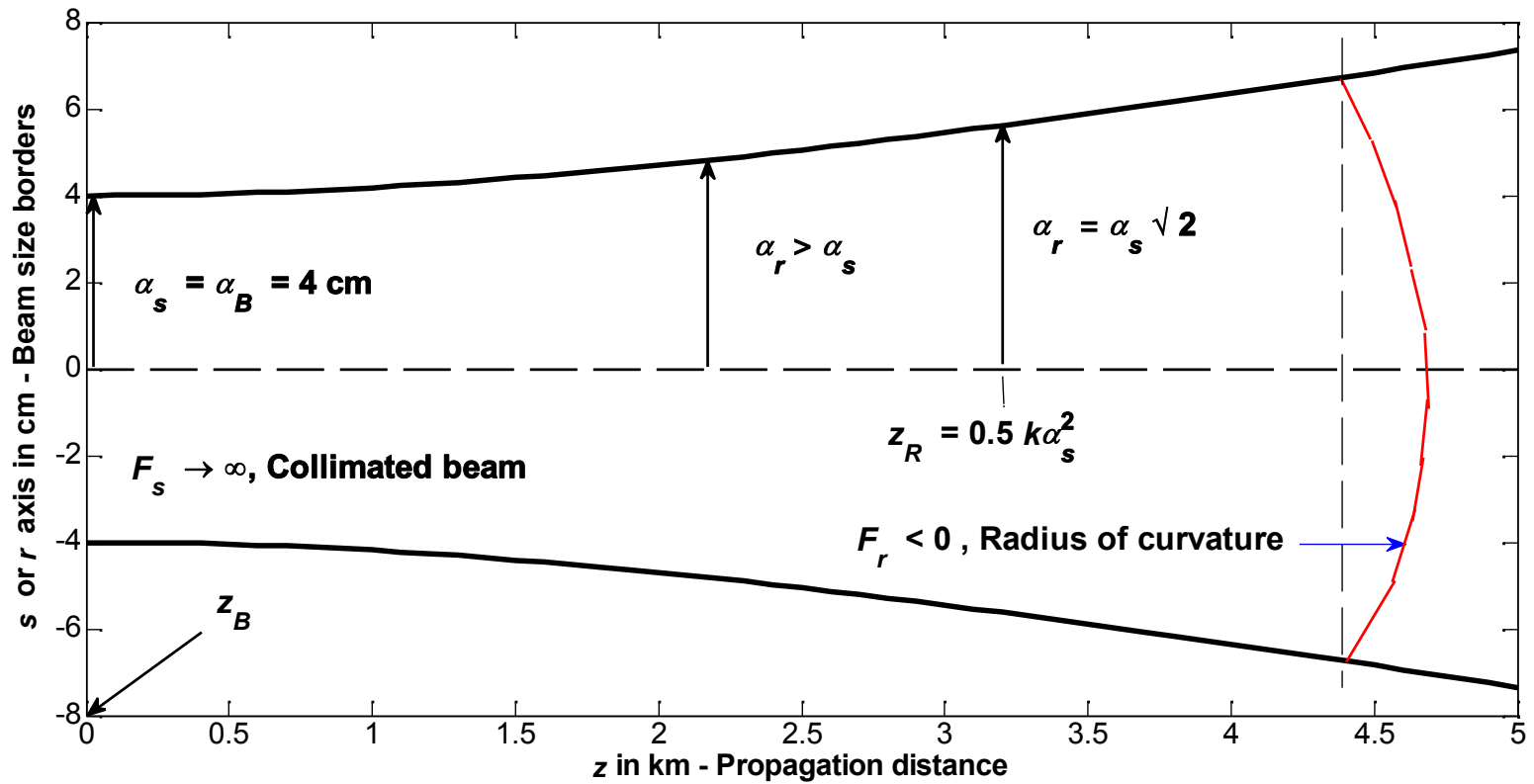

b)  $F_s > 0$ . This is called convergent or focused beam, the beam size first becomes smaller, then larger as we go away from the source plane as shown below



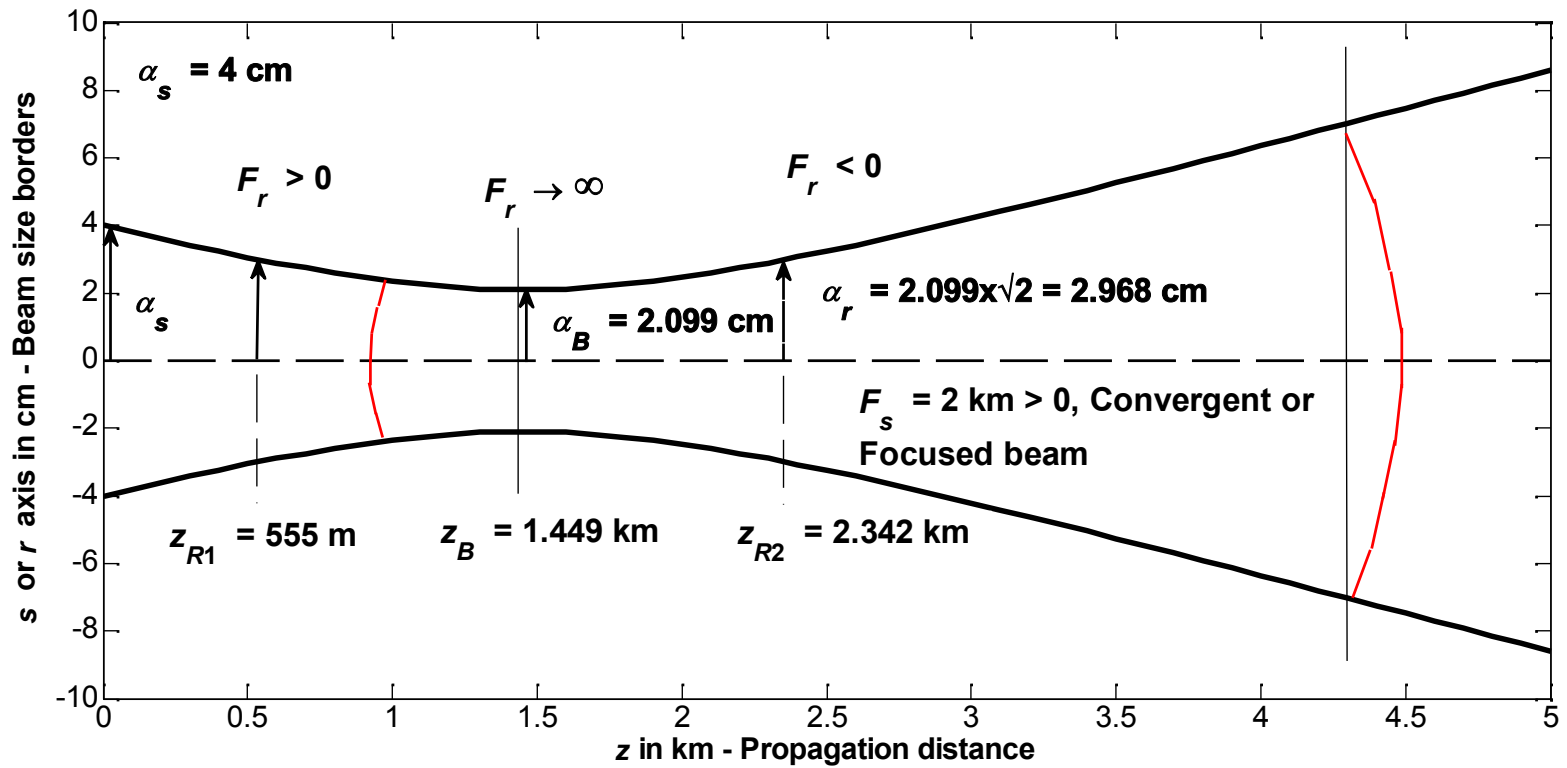

c)  $F_s < 0$ . This is called divergent beam, the beam always expands as we go away from the source plane as shown below

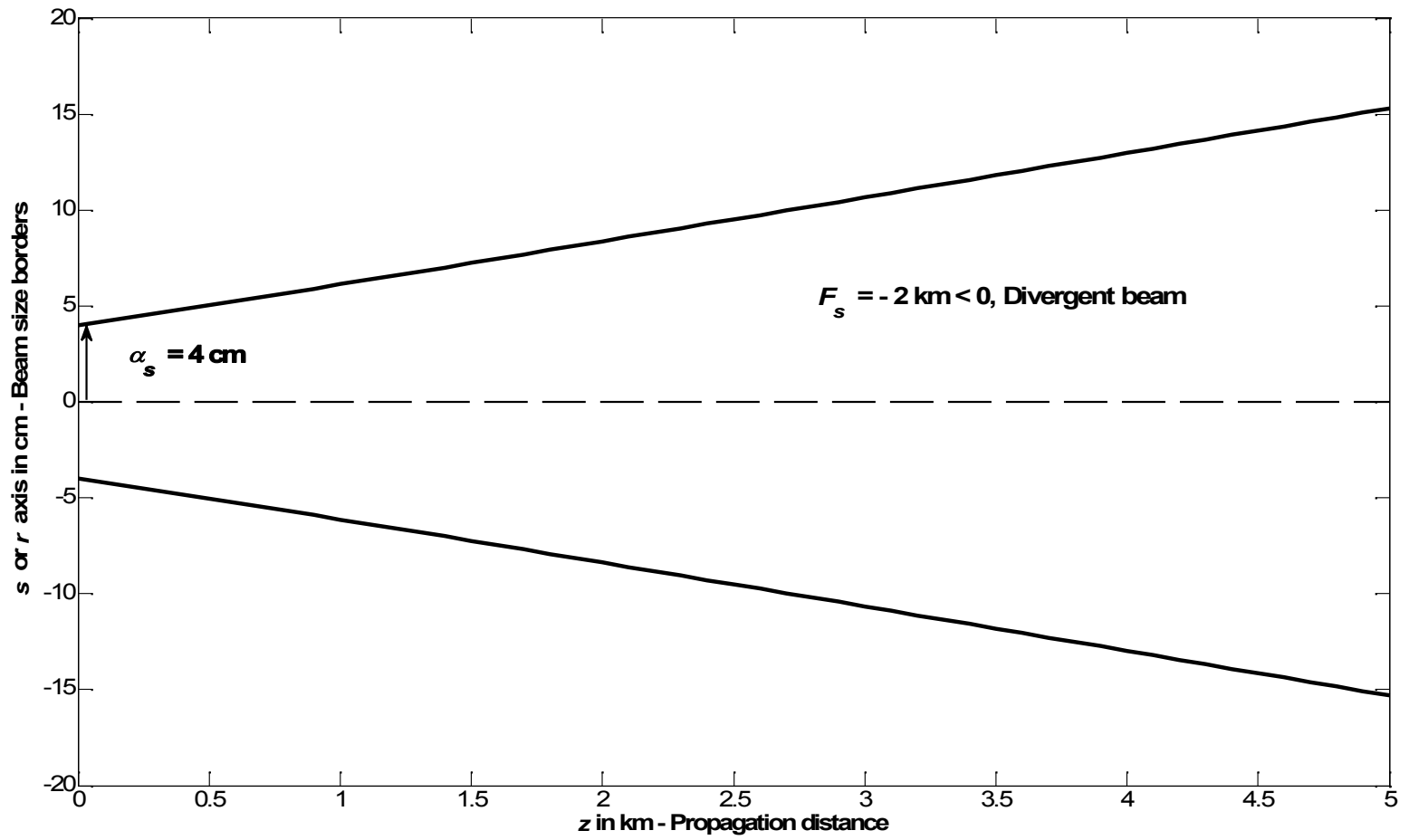

From the plot of focused beam, we see that, there is a minimum for beam size. To find the distance at which this minimum occurs ( $z_B$ ), we differentiate (G24) and set it to zero, hence  $z_B$  becomes

$$z_B = \frac{k^2 \alpha_s^4 F_s}{4F_s^2 + k^2 \alpha_s^4} \quad (\text{G29})$$

Then substituting (G29) into (G24), we get the smallest beam size along  $z$  axis, called beam waist and denoted by  $\alpha_B$  as

$$\alpha_B = \left( \frac{4\alpha_s^2 F_s^2}{4F_s^2 + k^2 \alpha_s^4} \right)^{1/2} \quad (\text{G30})$$

Finally in this section, we define Rayleigh, near field (Fresnel region) and far field (Fraunhofer region). Rayleigh range is the point in the propagation distance at which the beam size reaches  $\sqrt{2}$  times that of the smallest beam size. In the case of a collimated,  $\text{Min}(\alpha_r) = \alpha_s$ , hence in (G24), we let  $F_s \rightarrow \infty$  to find that  $z_R$  (Rayleigh range) located at  $z_R = 0.5k\alpha_s^2$  and divergent beams. For convergent beam on the other hand, there are two Rayleigh points extending on both sides of the beam waist. To find these points, we take  $\sqrt{2}\alpha_B$  from (G30) and place it on the LHS of (G24) and solve the resulting quadratic equation for  $z$  to get

$$z_{R_1} = \frac{k^2 \alpha_s^4 F_s - 2k\alpha_s^2 F_s^2}{4F_s^2 + k^2 \alpha_s^4}, \quad z_{R_2} = \frac{k^2 \alpha_s^4 F_s + 2k\alpha_s^2 F_s^2}{4F_s^2 + k^2 \alpha_s^4} \quad (\text{G31})$$

These are marked on the convergent beam graph given above.

**Sample problems from Andrews 2005, Chapter 4.**

1) (Example 1 of Andrews 2005) The following source beam is given

$\alpha_s = 3 \text{ cm}$ ,  $F_s = 500 \text{ m}$ ,  $\lambda = 633 \text{ nm}$ . For a receiver plane located at  $z = 1.2 \text{ km}$ , find the followings

- Beam size,  $\alpha_r$  on the receiver plane,
- Radius of curvature  $F_r$  on the receiver plane,
- On axis intensity  $I_r(r, \phi_r, z)$  at  $r = 0$  on the receiver plane,
- Propagation distance to beam waist,  $z_B$ ,
- Beam size at waist,  $\alpha_B$ ,
- Beam size at geometric focus, i.e.  $z = F_s$ .

**Solution :**

a) Using (G24) which is  $\alpha_r = \left( \frac{k^2 \alpha_s^4 F_s^2 - 2k^2 \alpha_s^4 F_s z + 4F_s^2 z^2 + k^2 \alpha_s^4 z^2}{k^2 \alpha_s^2 F_s^2} \right)^{1/2} = 4.28 \text{ cm}$  (P1)

b) Using (G28) which is  $F_r = -\frac{k^2 \alpha_s^4 F_s^2 - 2k^2 \alpha_s^4 F_s z + 4F_s^2 z^2 + k^2 \alpha_s^4 z^2}{4F_s^2 z - k^2 \alpha_s^4 F_s + k^2 \alpha_s^4 z} = -710.5 \text{ m}$  (P2)

c) Using (G25) which is  $I_r(r = 0, \phi_r, z) = \frac{A_c^2 \alpha_s^2}{\alpha_r^2} \exp\left(-\frac{2r^2}{\alpha_r^2}\right) = 0.492 \text{ W/m}^2$  assuming  $A_c = 1$  (P3)

d) Using (G29) which is  $z_B = \frac{k^2 \alpha_s^4 F_s}{4F_s^2 + k^2 \alpha_s^4} = 494 \text{ m}$  (P4)

e) Using (G30) which is  $\alpha_B = \left( \frac{4\alpha_s^2 F_s^2}{4F_s^2 + k^2 \alpha_s^4} \right)^{1/2} = 0.33 \text{ cm}$  (P5)

f) Inserting  $z = F_s = 500 \text{ m}$  in (P1), we get

$$\alpha_f = \left( \frac{k^2 \alpha_s^4 F_s^2 - 2k^2 \alpha_s^4 F_s^2 + 4F_s^4 + k^2 \alpha_s^4 F_s^2}{k^2 \alpha_s^2 F_s^2} \right)^{1/2} = \frac{2F_s}{k\alpha_s} = 0.34 \text{ cm} \quad (\text{P6})$$

2) (Problem 8 of Andrews 2005) For a collimated source beam with  $\lambda = 0.5 \mu\text{m}$ ,  $\alpha_s = 1 \text{ cm}$ , find the beam size and radius of curvature, i.e.  $\alpha_r$  and  $F_r$  on a receiver plane situated at  $z = 1 \text{ km}$ .

**Solution :** Using (G24) and letting  $F_s \rightarrow \infty$ , then which is  $\alpha_r = \left( \frac{k^2 \alpha_s^4 + 4z^2}{k^2 \alpha_s^2} \right)^{1/2} = 1.88 \text{ cm}$  (P8)

For  $F_r$  on the other hand, we use (G28) under the condition  $F_s \rightarrow \infty$ , then  $F_r = -\frac{k^2 \alpha_s^4 + 4z^2}{4z} = -1.395 \text{ km}$

3) (Problem 9 of Andrews 2005) A collimated beam with  $\lambda = 0.5 \mu\text{m}$  has a beam size of  $\alpha_r = 7 \text{ cm}$  at a distance of  $z = 10 \text{ km}$  from the source plane. Find the source size  $\alpha_s$ .

**Solution :** Recognizing that this is a collimated beam, i.e.,  $F_s \rightarrow \infty$  we use (P8) to get  $k^2 \alpha_s^4 - k^2 \alpha_r^2 \alpha_s^2 + 4z^2 = 0$  (P9).

By setting  $\alpha_{s2} = \alpha_s^2$ , we find the roots of (P9) as  $\alpha_s = 20 \text{ cm}$  and  $\alpha_s = 2.4 \text{ cm}$ . Among these solutions, only  $\alpha_s = 2.4 \text{ cm}$  is physically meaningful, since a beam size of  $\alpha_r = 7 \text{ cm}$  is not possible for a collimated beam with a source size of  $\alpha_s = 20 \text{ cm}$ .

4) (Problem 13 of Andrews 2005) A convergent beam with  $\lambda = 0.5 \mu\text{m}$  and  $\alpha_s = 5 \text{ cm}$  is observed at a distance of 500 m from the source plane with  $\alpha_r = 2 \text{ cm}$ . Identify the position of beam waist  $z_B$  and beam waist size  $\alpha_B$ , if it is

- Located somewhere between the source and the receiver plane at  $z = 500 \text{ m}$ ,
- Located somewhere beyond the receiver plane at  $z = 500 \text{ m}$ .

**Solution :** By inserting the given numeric values in (G24) and try to solve the resulting quadratic equation for  $F_s$  we get

$$0.84F_s^2 - 10^3 F_s + 24 \times 10^4 = 0 \quad (\text{P10})$$

The first root here will be  $F_{s1} = 833 \text{ m}$ . By inserting this into (G29) and (G30), we obtain the followings

$$z_{B1} = 830 \text{ m}, \alpha_{B1} = 2.65 \text{ mm} \quad (\text{P11})$$

From (P10), we get the second root as  $F_{s2} = 357 \text{ m}$ . Correspondingly  $z_{B2}$  and  $\alpha_{B2}$  will become

$$z_{B2} = 355 \text{ m}, \alpha_{B2} = 1.135 \text{ mm} \quad (\text{P12})$$

Here both solutions are equally valid as illustrated below.

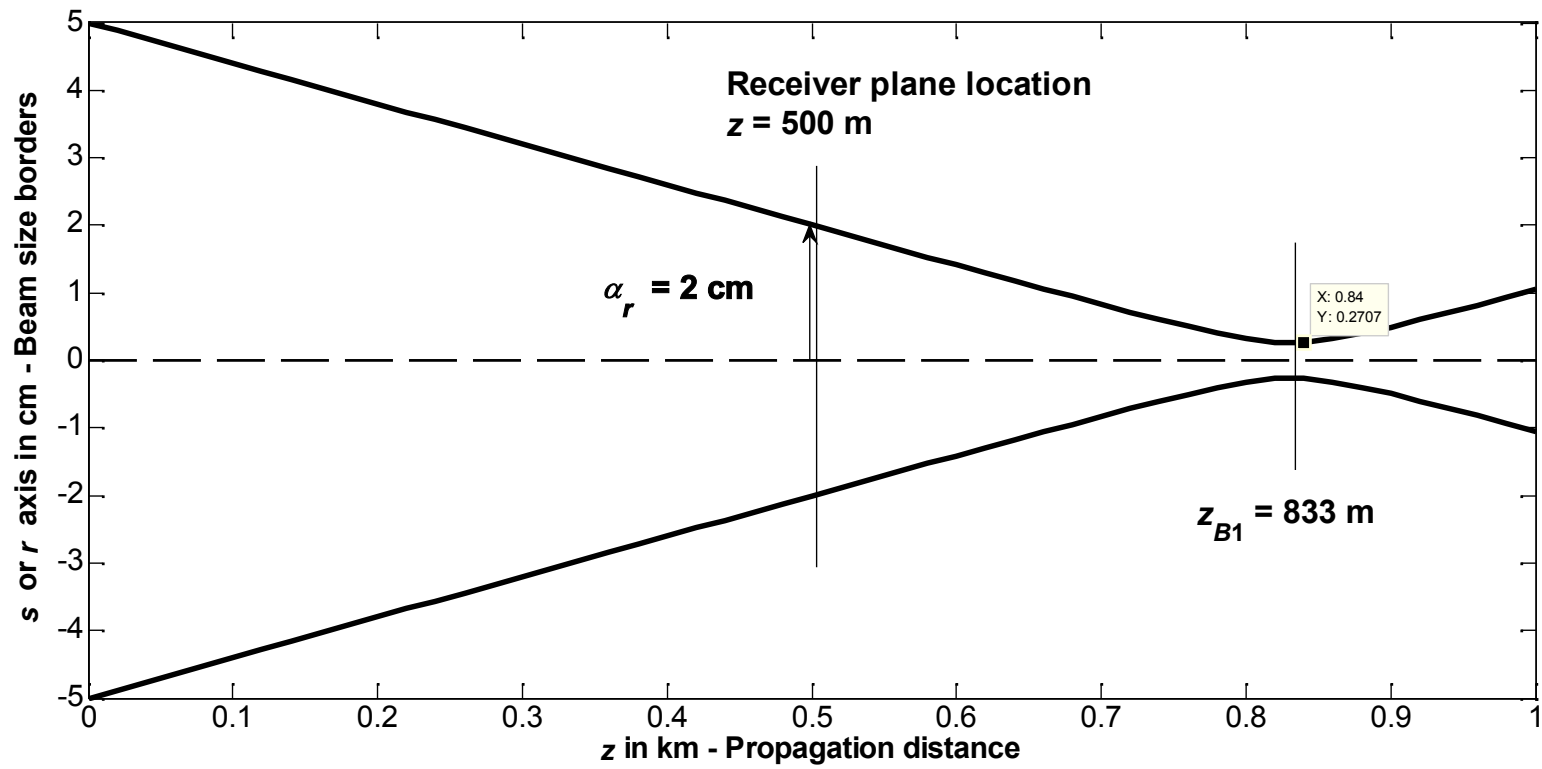

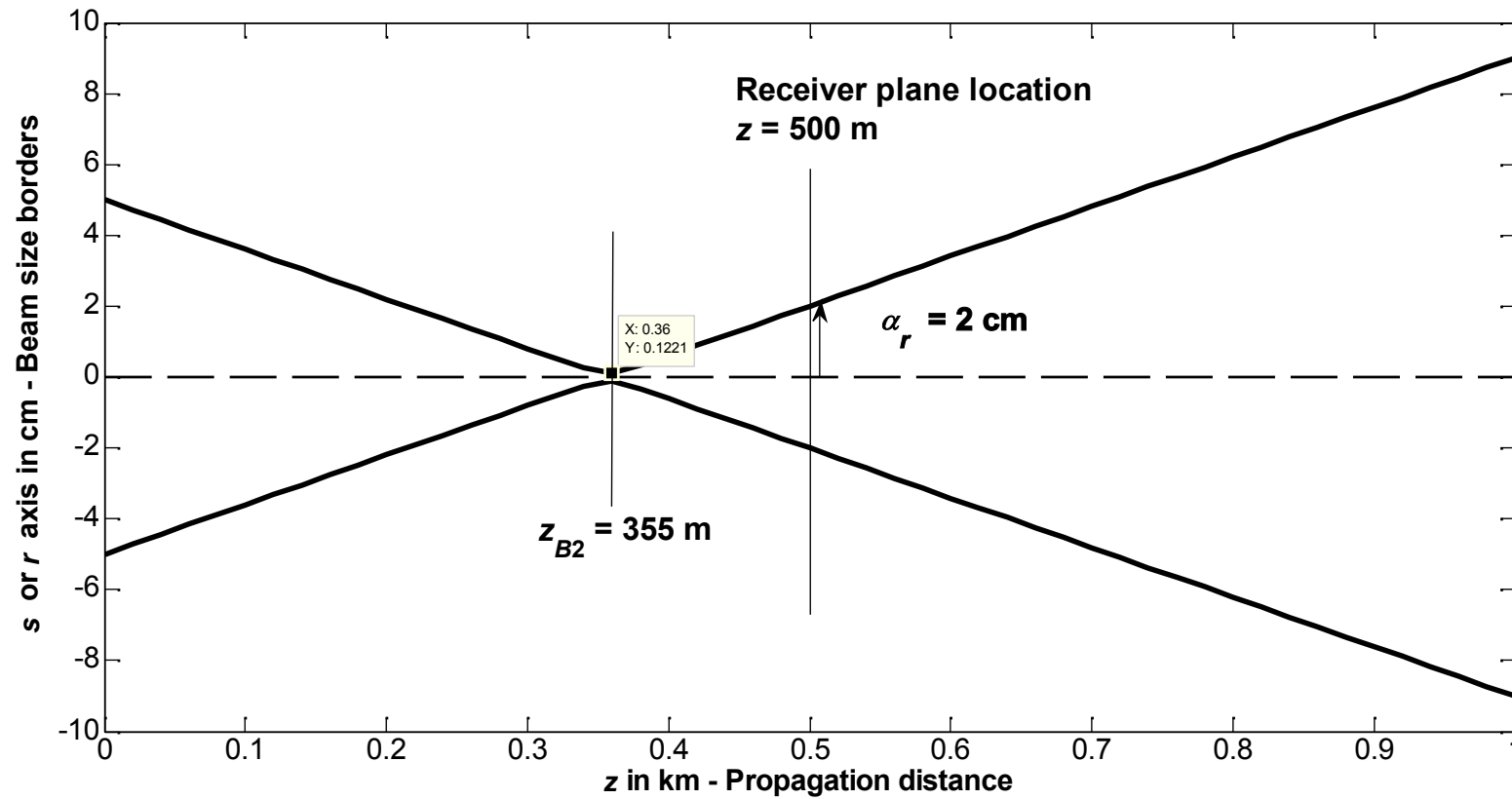

5) (Problem 19 of Andrews 2005) For the beam in problem 1) calculate the Rayleigh Range,  $z_{R_1}$  and  $z_{R_2}$

**Solution :** By using the formulation given in (G31),  $z_{R_1}$  and  $z_{R_2}$  are calculated as



$$z_{R_1} = \frac{k^2 \alpha_s^4 F_s^2 - 2k \alpha_s^2 F_s^2}{4F_s^2 + k^2 \alpha_s^4} \approx 439 \text{ m} \quad , \quad z_{R_2} = \frac{k^2 \alpha_s^4 F_s^2 + 2k \alpha_s^2 F_s^2}{4F_s^2 + k^2 \alpha_s^4} = 549 \text{ m} \quad (\text{P13})$$

From the numeric results of question 1), we see that  $z_B = 494 \text{ m}$ , hence  $z_{R_1} \leq z_B \leq z_{R_2}$  as predicted theoretically and as shown in the above illustration for the case of convergent beam. Now to show that the beam sizes  $\alpha_{r1}$  and  $\alpha_{r2}$  at  $z_{R_1}$  and  $z_{R_2}$  are equal using (G24) we calculate

$$\alpha_{r1} = \left( \frac{k^2 \alpha_s^4 F_s^2 - 2k^2 \alpha_s^4 F_s z_{R1} + 4F_s^2 z_{R1}^2 + k^2 \alpha_s^4 z_{R1}^2}{k^2 \alpha_s^2 F_s^2} \right)^{1/2} = 0.47 \text{ cm} \quad , \quad \alpha_{r2} = \left( \frac{k^2 \alpha_s^4 F_s^2 - 2k^2 \alpha_s^4 F_s z_{R2} + 4F_s^2 z_{R2}^2 + k^2 \alpha_s^4 z_{R2}^2}{k^2 \alpha_s^2 F_s^2} \right)^{1/2} = 0.47 \text{ cm} \quad (\text{P14})$$

- 6) (Problem 15 of Andrews 2005) A beam focused at 1 km with  $\lambda = 0.5 \mu\text{m}$  has  $\alpha_r = 8.9 \text{ cm}$  on a receiver plane located at  $z = 5 \text{ km}$ . For this beam
- Calculate source size, i.e.,  $\alpha_s$ ,
  - Calculate the radius of curvature on the receiver plane, i.e.,  $F_r$ ,
  - If the same beam is now focused at 5 km, what are  $\alpha_r$  and  $F_r$  at this distance.
  - Under the conditions given in c), find the beam waist, i.e.,  $\alpha_B$  and its distance to the source plane, i.e.,  $z_B$ .

**Solution :** a) By using the formulation given in (G24), we get an equation to the power of four of  $\alpha_s$  as stated below

$$\left( 1 - \frac{z}{F_s} \right)^2 k^2 \alpha_s^4 - k^2 \alpha_r^2 \alpha_s^2 + 4z^2 = 0 \quad (\text{P15})$$

After inserting the numeric values we get the roots as

$$\alpha_{s1} = 1.9869 \text{ cm} \quad , \quad \alpha_{s2} = 1.0015 \text{ cm} \quad (\text{P16})$$

Out of these solutions, the second one belongs to a divergent beam which will come from  $\left(1 - \frac{z}{F_s}\right)^2 = 16$  with  $z = 5$  km and  $F_{s1} = 1$  km (numeric values in the problem), but  $\left(1 - \frac{z}{F_s}\right)^2 = 16$  will also be satisfied by  $z = 5$  km and  $F_{s2} = -5/3$  km, where the negative value of  $F_s$  points to a divergent beam. Hence the following picture.

b) Use (G28) and  $\alpha_s = 1.9869$  cm,  $F_s = 1$  km to get  $F_r = -\frac{k^2 \alpha_s^4 F_s^2 - 2k^2 \alpha_s^4 F_s z + 4F_s^2 z^2 + k^2 \alpha_s^4 z^2}{4F_s^2 z - k^2 \alpha_s^4 F_s + k^2 \alpha_s^4 z} = -4.1706$  km (P17)

c) If  $F_s = 5$  km =  $z$ , then inserting this into (G24) we get the same as (P6), thus  $\alpha_f = \frac{2F_s}{k\alpha_s} = 4.02$  cm,  $F_r \rightarrow \infty$  (P18)

d) To calculate  $\alpha_B$  and  $z_B$  use (G30) and (G29). Thus  $\alpha_B = \left(\frac{4\alpha_s^2 F_s^2}{4F_s^2 + k^2 \alpha_s^4}\right)^{1/2} = 1.78$  cm,  $z_B = \frac{k^2 \alpha_s^4 F_s}{4F_s^2 + k^2 \alpha_s^4} = 987.5$  m (P19)

7) Inserting  $F_s \rightarrow \infty$  (i.e. collimated beam) in (G24), (G28), (G29) and (G30), find the more simplified expressions of  $\alpha_r$ ,  $F_r$ ,  $z_B$ ,  $\alpha_B$ .

**Solution :** The relevant expressions are given below

$$\alpha_r =_{F_s \rightarrow \infty} \left( \frac{k^2 \alpha_s^4 F_s^2 - 2k^2 \alpha_s^4 F_s z + 4F_s^2 z^2 + k^2 \alpha_s^4 z^2}{k^2 \alpha_s^2 F_s^2} \right)^{1/2} = \left( \frac{k^2 \alpha_s^4 + 4z^2}{k^2 \alpha_s^2} \right)^{1/2} \quad \text{the same as (P8)} \quad \text{(P20)}$$

$$F_r =_{F_s \rightarrow \infty} \left( -\frac{k^2 \alpha_s^4 F_s^2 - 2k^2 \alpha_s^4 F_s z + 4F_s^2 z^2 + k^2 \alpha_s^4 z^2}{4F_s^2 z - k^2 \alpha_s^4 F_s + k^2 \alpha_s^4 z} \right) = -\frac{k^2 \alpha_s^4 + 4z^2}{4z} \quad \text{(P21)}$$

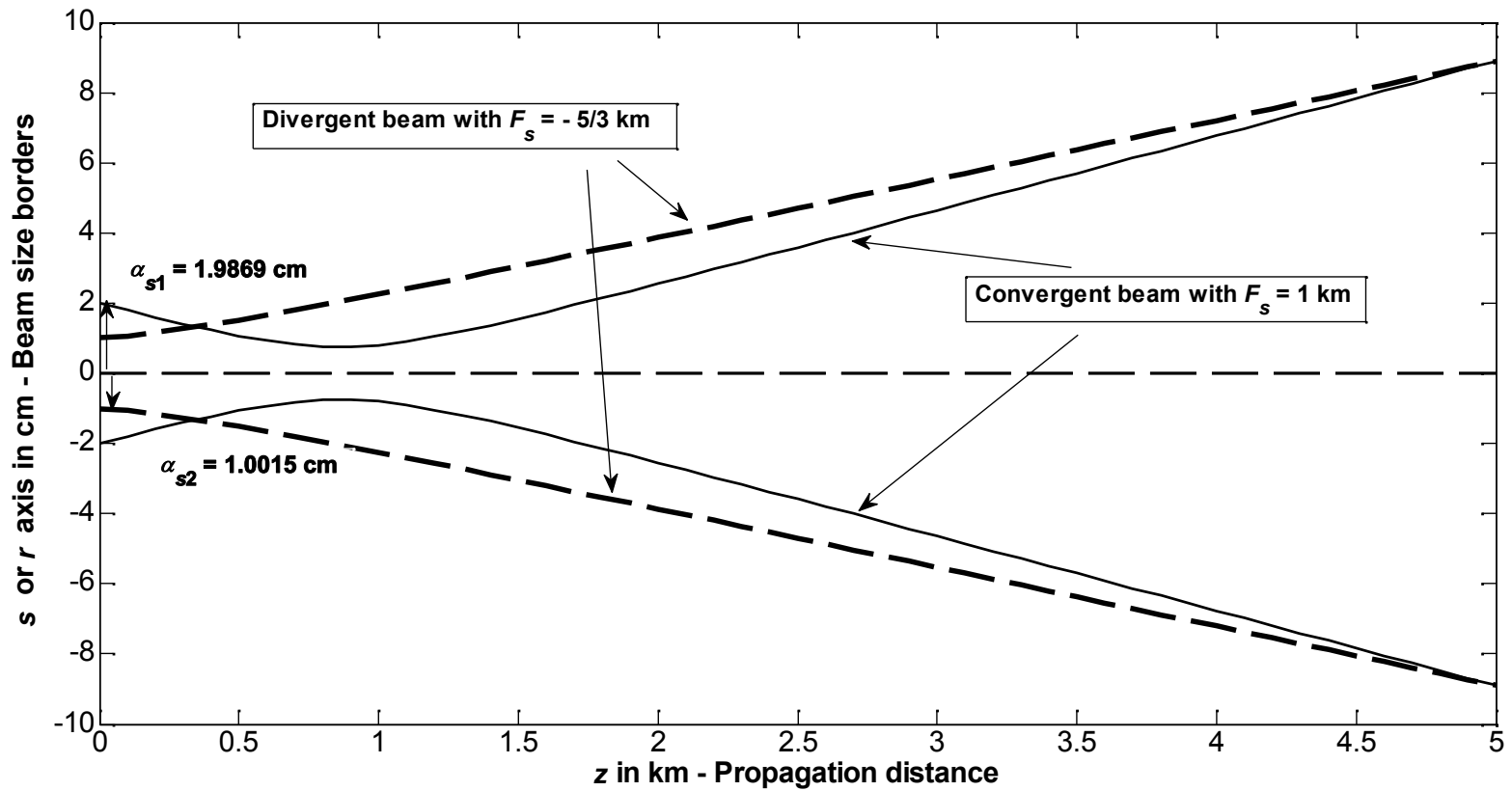

$$z_B = F_s \rightarrow \infty \left( \frac{k^2 \alpha_s^4 F_s}{4F_s^2 + k^2 \alpha_s^4} \right) = 0 \quad (\text{P22})$$

$$\alpha_B = F_s \rightarrow \infty \left( \frac{4\alpha_s^2 F_s^2}{4F_s^2 + k^2 \alpha_s^4} \right)^{1/2} = \alpha_s \quad (\text{P23})$$

Note that (P22) and (P23) are reasonable, since for a collimated beam, beam waist is located at source plane.

**Relationship between the physical sizes of  $\alpha_s$ ,  $\alpha_r$ ,  $F_s$ ,  $k(\lambda)$  and  $z$  (Applicable to convergent beam only) - **Misleading****

Considering (G24) and collecting terms on one side, we have

$$\left(k^2 F_s^2 - 2k^2 F_s z + k^2 z^2\right) \alpha_s^4 - k^2 \alpha_r^2 F_s^2 \alpha_s^2 + 4F_s^2 z^2 = 0 \quad (\text{R1})$$

Here the roots are

$$\alpha_{s1,2}^2 = \frac{k^2 \alpha_r^2 F_s^2 \pm \sqrt{k^4 \alpha_r^4 F_s^4 - 16F_s^2 z^2 \left(k^2 F_s^2 - 2k^2 F_s z + k^2 z^2\right)}}{2\left(k^2 F_s^2 - 2k^2 F_s z + k^2 z^2\right)} \quad (\text{R2})$$

So for a physically reasonable result, it should be that

$$k^4 \alpha_r^4 F_s^4 - 16F_s^2 z^2 \left(k^2 F_s^2 - 2k^2 F_s z + k^2 z^2\right) \geq 0 \quad (\text{R3})$$

Solving (R3) for  $\alpha_r^2$ , we get the relationship as

$$\alpha_r^2 \geq \frac{4z(F_s - z)}{kF_s} \quad \text{or} \quad \alpha_r^2 \geq \frac{4z(z - F_s)}{kF_s} \quad (\text{R4})$$